

Order Quotation

Invoicing Details	Shipping Details
Company name: _____ Delivery date required: ___/___/___ Delivery address: _____ P. Code.: _____ Town: _____ Tel.: _____ Fax: _____ # Order: _____ Date of the Order: ___/___/___	Ship to: _____ _____ <p style="text-align: center;">CUSTOMER STAMP AND SIGNATURE</p>

Pro Medicare srl grants **24 months** warranty on production defects from the date of the first put into service and **12 months** on covers and components subjected to wearing. Warranty is void if the product is used in any other way than stated in the Instruction Manual.

Note: Any request for variation in dimensions, materials and type compared to the standard does not have CE marking, therefore the professional user becomes the manufacturer and has the obligation to draw up the technical documentation of the device.

Images are purely illustrative and may not fully reflect reality.

Ermes-Giò Standard Configuration	
<ul style="list-style-type: none"> • Seat adjustable in width, depth also asymmetrically in adduction and abduction • Kit of inserts for a customised positioning of the pelvis • Reclining and height adjustable backrest • Kit of inserts for a customised positioning of the trunk • Multi-adjustable and removable containment and positioning kit: <ul style="list-style-type: none"> – pelvis (adjustable in width, depth, height, adduction/abduction) – arm support (adjustable in width, depth, height, angle, intra/extra rotation) • Male interface plate • Outdoor frame Adacta Giò with a solid grey base assembled with female interface plate: <ul style="list-style-type: none"> – Adacta titanium satin anodized frame which plates have the same color of the cover – Adjustable single handlebar with folding backrest tubes – Reclining mechanism by predetermined plate w/pin 3°, 10°, 18° – Seat depth adjustment – Continuous Tilt in space by drive lever: from 2° up to 35° (from 6° up to 39°) tilt in space can be up-graded of 4° with an increment of the starting inclination of the frame by operating on the positioning holes of the casters forks – Fixed anti-tip system – Wheels Kit with brake 	

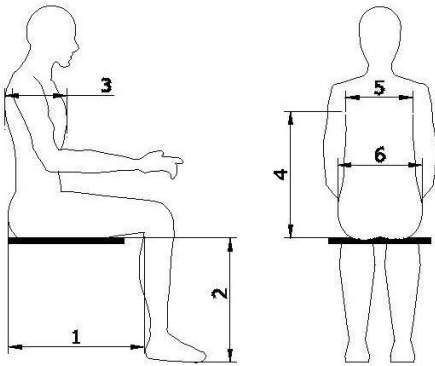
Sizes of the user			
	1 RH	depth of the seat RH	_____
	1 LH	depth of the seat LH	_____
	2 RH	length of the leg RH	_____
	2 LH	length of the leg LH	_____
	3 RH	depth of the thorax RH	_____
	3 LH	depth of the thorax LH	_____
4	height of the shoulders from the seat plane	_____	
5	width of the thorax	_____	
6	width of the pelvis	_____	
Note: ◇ = Standard ○ = Optional without up-charge □ = Optional with up-charge			

Ermes

<input type="radio"/> size 2	color	<input type="radio"/> blue/grey	<input type="radio"/> fuchsia/grey
<input type="radio"/> size 3	color	<input type="radio"/> blue/grey	<input type="radio"/> fuchsia/grey
<input type="radio"/> size 4	color	<input type="radio"/> wine/grey	

Type of the seat

<input type="radio"/> MIDI Seat <input type="radio"/> lateral/anterior control (standard configuration)		<input type="radio"/> DEEP Seat total control (PTS) optional without up-charge	
--	---	--	---





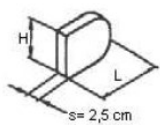
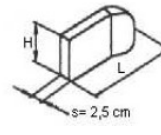

Greater closure of the seat-backrest angle ($\pm 5^\circ$)

Thoracic Supports

<input type="checkbox"/> Flat pads					<input type="checkbox"/> Contoured pads										
		Size (cm)		1	2	3	4			Size (cm)		1	2	3	4
		H	7	7	8	10	H			6	7	8	10		
		L	7.5	8.5	10	12	L			9.5	11	13	16		
Side	Size	Bracket type*		Bracket shape		Side	Size	Bracket type*		Bracket shape					
<input type="checkbox"/> RH		<input type="checkbox"/> Fixed <input type="checkbox"/> Swing-Away		<input type="checkbox"/> A <input type="checkbox"/> B		<input type="checkbox"/> RH		<input type="checkbox"/> Fixed <input type="checkbox"/> Swing-Away		<input type="checkbox"/> A <input type="checkbox"/> B					
<input type="checkbox"/> LH		<input type="checkbox"/> Fixed <input type="checkbox"/> Swing-Away		<input type="checkbox"/> A <input type="checkbox"/> B		<input type="checkbox"/> LH		<input type="checkbox"/> Fixed <input type="checkbox"/> Swing-Away		<input type="checkbox"/> A <input type="checkbox"/> B					



*In the technical information at the end of this form you can find the dimensions reachable with the two types of brackets (A type = L/90° Bracket; B type = 2.5 cm Offset Bracket)

Belts and Harnesses (values expressed in cm, see details in the technical information)

<input type="checkbox"/> Chest pad			<input type="checkbox"/> Dynamic Abduction Harness			<input type="checkbox"/> Pelvic belt		
 (with thoracic supports only)	Size	HxL		<input type="checkbox"/>	XS (2)*		Size	HxL
	<input type="checkbox"/> 1	(8x10)		<input type="checkbox"/>	S (3)*		<input type="checkbox"/> 1	(6x11)
	<input type="checkbox"/> 2	(9x13)		<input type="checkbox"/>	M (4)*		<input type="checkbox"/> 2	(7x13)
	<input type="checkbox"/> 3	(10x13)					<input type="checkbox"/> 3	(7x15)
<input type="checkbox"/> Dynamic Butterfly Harness			<input type="checkbox"/> Jacket Harness			<input type="checkbox"/> Contoured Pelvic Belt		
	<input type="checkbox"/>	XS (2)*		<input type="checkbox"/>	XS (2)*		Size	HxL
	<input type="checkbox"/>	S (3)*		<input type="checkbox"/>	S (3)*		<input type="checkbox"/> 1	(6x11)
	<input type="checkbox"/>	M (4)*		<input type="checkbox"/>	M (4)*		<input type="checkbox"/> 2	(8x15)
							Value H is referred to the height of the central part of the pad	

*The number in the brackets is referred to the relevant Ermes size. Therefore it is **advisable** to combine the default size.

Hardrest with multi-axial joint and multi-adjustable arm

<input type="checkbox"/> Confort with			<input type="checkbox"/> Anatomic with			<input type="checkbox"/> 3 piece pads supportive headrest with		
<input type="checkbox"/> detachable hardware <input type="checkbox"/> fixed hardware			<input type="checkbox"/> detachable hardware <input type="checkbox"/> fixed hardware			<input type="checkbox"/> detachable hardware <input type="checkbox"/> fixed hardware		
	<input type="checkbox"/>	S		<input type="checkbox"/>	XS		<input type="checkbox"/> 1	(7x13)
	<input type="checkbox"/>	M		<input type="checkbox"/>	S		<input type="checkbox"/> 2	(9x20)
	<input type="checkbox"/>	G		<input type="checkbox"/>	M		values expressed in cm of the occipital pad only	

Other accessories



Knee elevating legrest RH LH
(with cover for angle knee)

separate footplates: RH LH

Footplate options: slotted separate footplates: RH LH

footboard (it does not allow asymmetry, adduction and abduction)



Shoes Holders



Calf support RH LH

Calf panel (it does not allow asymmetry, adduction and abduction)

Lateral supporting pad for legs RH LH

Padded anterior/posterior Calf strap

Padding for separate footplates

Padding for footboard

Elbow lateral-posterior support RH LH

- Grey detachable Tray**
with body contouring recess and edges
- standard version
 - larger version for daily activities

- Transparent detachable Tray**
with body contouring recess and edges
(only standard version)

Note: the dimensions of the tray in the standard grey color version and those of the transparent tray are the same, the naming changes (the size 2 of the grey tray will be the size 1 of the transparent tray, 3->2, 4->3)

standard version dimensions

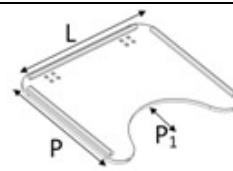

Size (cm)	L	P	P1
2 (for Ermes size 2)	40	35	12
3 (for Ermes size 3)	48	40	13.5
4 (for Ermes size 4)	58	45	15.5

larger version for daily activities dimensions

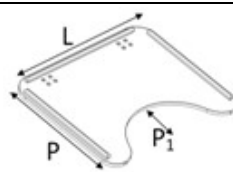

Size (cm)	L	P	P1
1 (for Ermes size 2)	50	45	13.7
2 (for Ermes size 3)	60	50	15.4
3 (for Ermes size 4)	68	55.6	19.3

Padding of the tray upper lower

Adacta Giò frame options for Ermes

Castors

150mm (6") poly grey black

175mm (7") poly grey black

Posterior Wheels

- 300mm (12") poly grey with parking brake lever
- 300mm (12") poly black with parking brake lever
- 300mm (12") pneumatic grey with parking brake lever

- 300mm (12") poly black with drum brake
- 300mm (12") poly grey with drum brake
- 300mm (12") pneumatic grey with drum brake

- 300mm (12") poly black with drum brake and parking brake lever
- 300mm (12") poly grey with drum brake and parking brake lever
- 300mm (12") pneumatic grey with drum brake and parking brake lever

400mm (16") poly black with parking brake lever (only 45 cm height)

400mm (16") poly black with drum brake (only 45 cm height)

400mm (16") poly black with drum brake and parking brake lever (only 45 cm height)

- 500mm (20") poly grey without handrims with parking brake lever
- 500mm (20") pneumatic grey without handrims with parking brake lever
- handrims for 500mm (20") wheels

500mm (20") pneumatic grey with handrims with drum brake

500mm (20") pneumatic grey with handrims with drum brake and parking brake lever

Back Posts

- Kit for fixed push handles
- Kit for telescopic and angle adjustable single handlebar
- Kit for telescopic push handles with lever block (max adjustment 10 cm)
- Kit for angle adjustable separated handlebar
- Quick-release pins for easier back reclining

Tilt in space	<input checked="" type="checkbox"/> with pedal	<input type="checkbox"/> with lever	
Canopy adaptor included	<input type="checkbox"/> Blue	<input type="checkbox"/> Pink	<input type="checkbox"/> Bordeaux
<input type="checkbox"/> Basket			
<input type="checkbox"/> Rain cover			
Foot muff	<input type="checkbox"/> Blue	<input type="checkbox"/> Pink	<input type="checkbox"/> Bordeaux
<input type="checkbox"/> Supplementary frame for Tipco indoor base	<ul style="list-style-type: none"> - Height adjustable seat by gas spring - Tilt in space by gas spring from -5° up to +30° - 4 swivel castors (2 with locks) - Multi-adjustable push handle - Interface female plate 		
<p>Note: If Ermes' sizes 2/3 are chosen, Tipco indoor base will be in white color; if Ermes' size 4 is chosen, Tipco indoor base will be in grey color</p>			

TECHNICAL INFORMATION

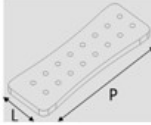
Ermes	Size 2	Size 3	Size 4	
Width of the Seat (cm)	≤25	18-28	22-35	
Depth of the Seat (cm)	19-26	22-34	31-43	
Height of the trunk (cm)	26-38	33-45	41-53	
Width of the thorax (cm)	bracket A 19-25	bracket A 22-28	bracket A 27-33	
	bracket B 14-20	bracket B 17-23	bracket B 22-28	
Max abduction of the leg (°)	16	16	16	
Max adduction of the leg (°)	16	16	16	
Popliteal Space to footplate Length (cm)* <i>*if the elevating knee angle is provided</i>	8-19	8-29	8-39	
Height of the arm support (cm)	14-19	20-26	20-26	
Backrest Reclining (°)	-3+20	-3+20	-3+20	
Ermes load (kg)	25	35	50	
Ermes weight (kg)	5.2	8.1	12.1	
Contoured hip guide	Size 2	Size 3	Size 4	
	H	6.5	7	8
	P	17	20	23
Flat arm support	Size 2	Size 2	Size 3	
	L	7.5	7.5	8.5
	P	17	20	23
Note: the postural unit for armrest and the lateral hip pad are combined to the relative size of Ermes and are not interchangeable				
Adacta Giò	Size 2	Size 3	Size 6	
Seat to floor height (cm)	43	43	43	
Width overall dimension (400/500 wheels) (cm)	48	53	58	
Min/max depth overall dimensions (cm)	73-100	75-102	81-109	
Tilt in space (°)	2-35 (from 6 up to 39) <i>tilt in space can be up-graded of 4° with an increment of the starting inclination of the frame by operating on the positioning holes of the casters forks</i>			
Predetermined backposts reclining (°)	3-10-18			
Adacta Giò load (standard configuration) (kg)	30	50	50	
Adacta Giò weight (kg)	12.8	13.4	14.5	
Total weight (Adacta Giò+Ermes) (kg)	18	21.5	26.6	
Tipco	Size 2	Size 2	Size 3	
Seat to floor height (cm)	63	63	63	
Width overall dimension (cm)	67	67	67	
Depth overall dimensions (cm)	80	80	88	
Tilt in space (°)	-5+30	-5+30	-5+30	
Tipco Load (kg)	50	50	50	
Total Weight (Tipco+Ermes) (kg)	18.8	21.7	26.1	



PRO MEDICARE S.r.l.
 Via Montagna Z.I. Lotto 41-72023 Mesagne (Br)-ITALY
 Tel: +39-0831-777840 Fax:+39-0831-730739
 Sito web: www.promedicare.eu e-mail: sales@promedicare.it