



Anatomico **and** Comfort  
Head support systems

# capitis Confort

The ideal comfort for the head

## Pads



SMALL Pad  
PMDC04P



MEDIUM Pad  
PMDC04M



LARGE Pad  
PMDC04G



Anti-decubitus padding



Removable cover lycra/neoprene air-x-change



Breathable



Fire retardant



Multi-adjustable and pivoting

## Hardware



LONG Horizontal Bar  
PMDC02



SHORT Horizontal Bar  
PMDC02C



Vertical Bar  
PMDC01

## Mounting examples



## Configurations

Capitis confort including hardware with **Long horizontal bar** and detachable mounting unit

ART.	SIZE
PMDC01P	Small
PMDC01M	Medium
PMDC01G	Large

Capitis confort including hardware with **short horizontal bar** and detachable mounting unit

ART.	SIZE
PMDC01PC	Small
PMDC01MC	Medium
PMDC01GC	Large

## Technical features

### CAPITIS CONFORT MEASUREMENTS expressed in centimeters

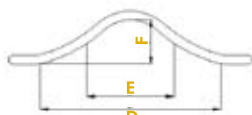
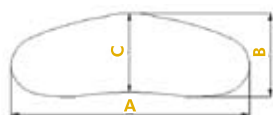

ART	A	B	C	D	E	F
PMDC04P	21	14	13	15	08	04
PMDC04M	30	14	13	24	10	05
PMDC04G	42	16	14	34	14	07

### CAPITIS ANATOMICO MEASUREMENTS expressed in centimeters

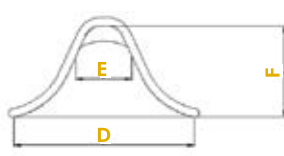
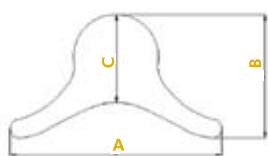

ART	A	B	C	D	E	F
PMDC03XP	18	13	08	13	04	02
PMDC03P	24	17	12	19	06	04
PMDC03M	28	19	13	21	08	06
PMDC03G	32	25	16	23	08	08

"For partially sighted users this document can be visualized in PDF format on the web site [www.promedicare.it](http://www.promedicare.it) with the option to enlarge the text."



EXTRA SMALL Pad  
PMDC03XP



SMALL Pad  
PMDC03P



MEDIUM Pad  
PMDC03M



LARGE Pad  
PMDC03G



Low Profile and  
Soft padding



Removable Cover  
lycra/neoprene air-x-change



Breathable



Fire retardant



Multi-adjustable  
e pivoting



Detachable  
Mounting unit  
PMDC06



Kit of alluminium  
multadjustable  
Hardware with  
horizontal bar  
LONG PMDC05  
SHORT PMDC05C



Capitis anatomico including hardware with long horizontal bar and detachable mounting unit	ART.	SIZE
	PMDC02XP	Extra Small
	PMDC02P	Small
	PMDC02M	Medium
	PMDC02G	Large

Capitis anatomico including hardware with short horizontal bar and detachable mounting unit	ART.	SIZE
	PMDC02XPC	Extra Small
	PMDC02PC	Small
	PMDC02MC	Medium
	PMDC02GC	Large

## Range of depth adjustments

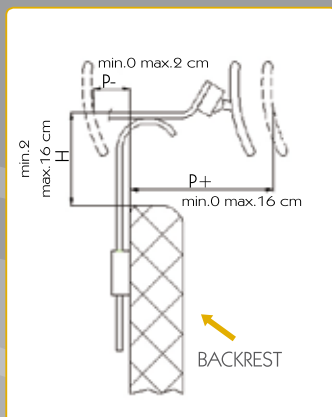

Horizontal bar  
upward orientated

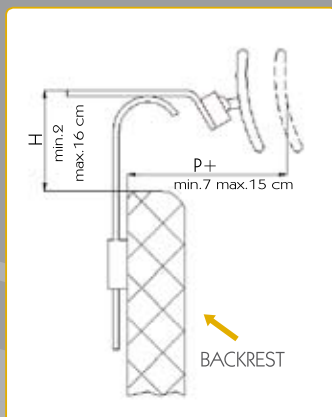

Horizontal bar  
downward orientated

## Accessories

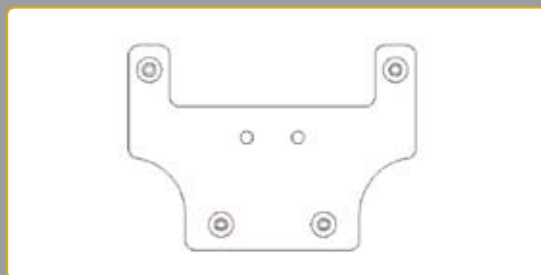

### Mounting Interface Plate for backrests

Mounting interface plate for backrests with plastic or aluminum shell. The Capitis system can be mounted on solid backrests only.



MANUFACTURED BY:



Via Montagna Z . I . L o t t o 4 1  
c.a.p. 72023 Mesagne (Br) - ITALY  
T e l . + 3 9 0 8 3 1 . 7 7 7 8 4 0  
F a x . + 3 9 0 8 3 1 . 7 3 0 7 3 9  
W e b s i t e : [www.promedicare.it](http://www.promedicare.it)  
e m a i l : [info@promedicare.it](mailto:info@promedicare.it)

DISTRIBUTED BY:

